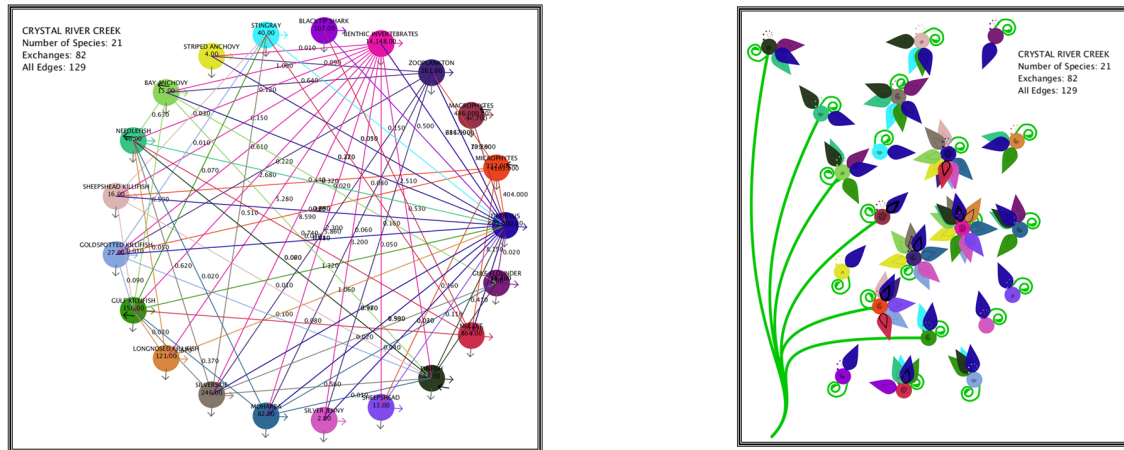


# Daisy Visualization for Graphs

Katayoon Etemad,<sup>†</sup> Faramarz Samavati,<sup>‡</sup> and Sheelagh Carpendale<sup>§</sup>



**Figure 1:** Node-link layout (left) and Daisy Visualization (right) for 21 species ecological network of “Crystal Creek River”. Species are represented by Daisy cores and the relationship between species (flow of energy/matter) is represented by partial edges that are designed as Daisy petals.

## Abstract

Since graphs are ubiquitous representations of data that are used in many applications, creating graph layouts is an important problem. These graph layouts are usefully discussed in terms of aesthetics that originated from mathematical concepts. In contrast, we explore the use of alternative aesthetics to inspire the visualization of graphs. We present Daisy Visualization, for which we have designed a new graph layout that is inspired by ornamental patterns of daisy flowers. In Daisy Visualization, graphs’ attributes are mapped to floral elements. **Artistic information visualizations attract more viewers and catch more attentions.** As a practical use case we apply Daisy Visualization to the layout of ecological networks based on real ecosystem datasets. We show how specific attributes of ecological networks such as input/output edges, or respiration, can be mapped to floral elements. We conducted a qualitative assessment of Daisy Visualization, where we obtained overall positive feedback and interesting specific thoughts about various design decisions and possible future directions.

Categories and Subject Descriptors (according to ACM CCS): Graph Visualization, Ecological Networks, Weighted Directed Graphs.

## 1. Introduction

One of the active areas of information visualization is graph visualization, which lies on the intersection of graph drawing and infor-

mation visualization. Graphs are well-known mathematical models for representing objects and their relationships. A graph is defined by a set of nodes and their pairwise connections, represented by edges. Graphs are commonly used for modeling networks (e.g. communication, social network and transportation), interconnected systems (e.g. ecological, energy, financial), and complex structures (e.g. organizations, molecular and data structure).

It is a challenging task to present large or complex graphs

<sup>†</sup> ketemad@ucalgary.ca

<sup>‡</sup> samavati@ucalgary.ca

<sup>§</sup> sheelagh@ucalgary.ca

in the space of a screen, due to the possibility of nodes overlapping and edges crossing. These factors can make it difficult for people to explore the information presented in large or complicated graphs [Zha07]. Attractive and engaging visualizations of graphs have been shown to help analysts in their exploration tasks [CM07]. For more casual environments, aesthetically pleasing information visualizations may invoke curiosity, and excitement [PSM07]. Also, in public spaces, this type of artistic information visualization can catch the attention and attract the potential viewers. Aesthetic appeal has become a major concern in visualizations integrated into the larger environment [SLH03, CM07].

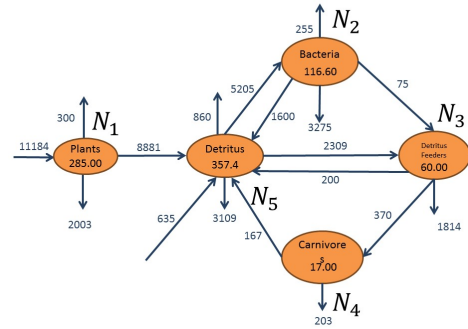
Aesthetics have long played an important role in graph drawing. Graph drawing aesthetics have been a topic of research for approximately the last thirty years [EL00, DBETT94]. The common ideas used in this area are based on measurable notions such as edge crossings, edge bending, and the number of incident edges. We agree that these graph drawing aesthetics have a type of beauty and are aware that they have also been shown to improve readability [Pur97]. In HOLA [KDMW16] authors introduced an orthogonal network layout, following a human-centered methodology. They asked their participants to draw a graph layout with their own desire, and as the result they observed that participants prefer less crossings or bends and more symmetry and regular grids. However, our intention in this paper is to expand these notions of aesthetics. In our world there are a multitude of aesthetics arising from different cultures and different artistic practices. It is this wide variation of aesthetics we draw from when we refer to *alternate aesthetics*. A variety of well-accepted aesthetic patterns can be considered as sources of inspiration for designing new visualizations including graph visualizations. However, the question is: How can a selected pattern be mapped to new graph layouts? Answering this question can be challenging due the following three objectives which are sometimes in conflict with each other:

- Accuracy and clarity of the representation,
- Pleasant appearance, and its match to selected patterns,
- Usefulness in practical scenarios.

We introduce Daisy Visualization, a new graph visualization with a novel layout which was inspired by ornamental patterns of daisy flowers. Floral patterns have been popular and well received for a long period of our history. Thus, they can be great sources of inspiration for designing novel information visualization systems. There are countless images of inspiring floral examples. The challenge is to find a pattern that can effectively be mapped to data elements.

In respect to *usefulness in practical scenarios*, we use the visualization of ecological networks as our practical use case. These networks are a specific example of weighted directed graphs [Ula]. Ecological networks have complicated structures which makes their visualization more challenging. In these networks, nodes represent species in the ecosystem, and node's weight represents the species' biomass. Edges represent the energy/matter flow between species, and are categorized into four groups: Inputs, Outputs, Respirations and Exchanges, each of which is weighted and directed. Exchange edges represent the relations between nodes in the ecosystem, while other types represent the relations between

ecosystem and outside environment. Figure 2 shows a simple five-node example of this type of network. In this diagram the weight of nodes and edges are simply added as numerical labels. The weight of each edge shows the amount of material that flows from one node to another. Directions are shown via arrows. Note that even a small example of these networks, with only five nodes, is complex.



**Figure 2:** Ecological network with five nodes. Nodes have weights, indicating the biomass of the species they represent. Edges are weighted and directed, to represent the amount and direction of energy/matter, that flows between species.

In our resulting visualization we map nodes of the network to daisy flower cores, and edges of the network to daisy flower petals. Further, we re-arrange the direction of petals to represent edge's direction, and use venation designs inside petals to represent the edge's weight.

Our main contributions include: design of a novel layout for weighted and directed graphs; applying this layout to ecological networks; developing the Daisy Visualization prototype; and conducting a qualitative study of people's responses to the Daisy graph visualization. We gathered feedback from participants about our design decisions, and collected their overall impressions about the visualization.

## 2. Related Work and Background

We review the relevant related work and explain our inspiration through a short review of work that relates to generating ornamental patterns.

### 2.1. Graph Drawing

The difference between graph drawing and graph visualization is slightly fuzzy. Graph drawing methods are commonly algorithmic and are usually designed to efficiently manage the geometric aspects of graphs by arranging their nodes and drawing edges with respect to a set of factors [KW03] [BF14]. Graph visualization, similar to other areas of information visualization, refers to a visual representation to augment human cognition [Mun14]. Therefore, in addition to geometric layout of graphs, other encoding attributes such as colors, shades, symbols, icons, line styles and labels are used for the final representation. Furthermore, visualizations tend to include interactive techniques such as focus+context, zoom/pan,

clustering and filtering [Mun14] to support exploration of the graph and its elements. Also, there are many graph visualization methods that rely on an adjacency matrix layout which is less common for graph drawing [HMM00]. **The potential of using botanical features in data visualization is partially evidenced by PhyloTrees [NCA06] and Botanical trees [KvDWVW01].**

### 2.2. Graph Visualization

For a comprehensive review of graph visualization, see surveys by Herman [HMM00] and von Landesberger [vLKS\*]. We briefly review the most relevant research.

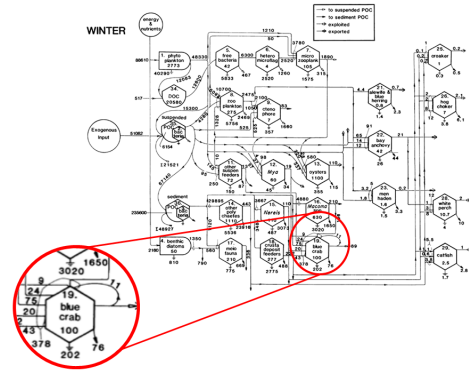
Graph visualization challenges include visualizing attributes such as weight and direction. In simple node-link drawings, the direction of an edge can be represented by a line with an arrowhead [ESK05] or by tapering curves [HvW09]. When many edges are connecting nodes, adding details like arrowheads can cause more clutter in the visualization. In recent directed graph visualizations, the direction is represented by the thickness of edge from origin to the destination nodes [HvW09]. Partial Linked Drawing [BSPW14] visualizes directed graphs by partially representing edges [BVKW11]. In Node-Ring Visualization [ECS], the traditional form of edges is replaced through using colors and shades to represent directional edges. The directed edges are simply implicitly presented inside their original node and the weight of the edge is mapped to the angular size of the corresponding arc.

Edge weights can be included in a graph visualization as labels for the edges. This method adds to the cluttering issue and does not offer a visual representation of the edge. The weighted edges in node-link graph visualizations are usually represented by either mapping the weight to the length [CKN\*03] or the thickness [ECW\*12,ECS14] of the edge. While in matrix visualizations, attributes of edge like weight can be mapped by the color of the corresponding cells [vHSD09]. Studies show that node-link visualizations in which weighted edges are mapped by thickness of links are preferred [ABHR\*13].

### 2.3. Ecological Networks

Visualization of ecological networks is our practical use case. These networks are a specific example of weighted directed graphs [Ula]. Understanding ecosystems both from the perspective of necessary exchanges within the ecosystems and from their relationships and possible impact upon other external entities is challenging. The complexity of this type of networks arises from internal and external exchanges, energy flows, cycles and dynamics. The primary purpose of these networks is to support ecologists in their analysis and exploration of ecosystems, and to use visualization to gain a better understanding of exchanges of nutrients and energy that form the dynamics and flow of the ecosystem [Ula04]. These networks often contain one or more cycles [BM76]. Figure 3 shows a more complex ecological network with 28 nodes. In this figure all relationships between species are represented by traditional node-link layout, which is a combination of orthogonal node-link and simple node-link layouts.

While it may be tempting to think that traditional graph visualizations would be adequate for ecosystem networks most of the



**Figure 3:** Simple node-link diagram is not sufficient for presenting this data [BU89].

details that are of particular interest to ecologists get suppressed, and the complexity of even small networks becomes visually overwhelming. Etemad et al. [ECS14] presented an alternate approach to visualizing eco-networks that was based on spirograph patterns. This approach made a clear visual distinction between internal and external edges, however, the internal edges still suffered from congestion problems. Inspired by this, in Daisy graph Visualization we keep the strong visual distinction between internal and external edges by using different floral elements.

### 2.4. Artistic Inspiration



**Figure 4:** Ornamental patterns have been used for decorating books and buildings for several years. These are abstractions of floral patterns inspired by nature.

Floral ornaments are well accepted aesthetic patterns that have been used for decorating buildings, carpets, furniture, and illuminating books and textiles for more than two thousand years [Pal65] (see Figure 4). These mesmerizing patterns are inspired by nature and they are abstractions of real plants and flowers. Their various forms and styles have been adopted by different cultures. Much effort in art and design has been spent on enhancing these patterns and optimizing them for use in traditional contexts (e.g. books, stones, walls). Figure 4 shows some examples of these patterns in traditional contexts.

Recreating these patterns for digital media has been investigated in computer graphics for many years. Procedural modeling techniques, particularly L-systems, are commonly used for creating the complex and repetitive structure of these patterns [Smi84, WZS98, PL96, ESP08]. In essence, an algorithm, or some high-level grammars are used for creating the structure and its ornamentations. A number of techniques have been proposed for creating a particular

class of patterns. Etemad et al. have considered the recreation of Persian floral pattern [ESP08]. Hamekasi and Samavati [HS12] analyze and generate Persian floral patterns, while taking advantage of circle packing concepts and tools.

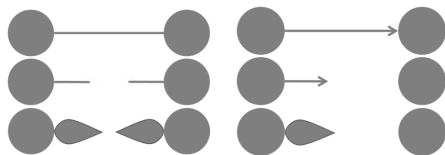
Our interest in floral patterns is different from the above research papers which mostly focus on the challenges of generating the patterns in an algorithmic way. In our work, we need to assign a specific meaning to these patterns beyond their apparent shapes and colors. There are several works in information visualization which share the same goal as ours. For example in Keystrokes [NTZC07], a visualization of typed messages, Neumann et al. use petal shapes to represent messages with semi-transparent artistic strokes. Based on the pattern of the typed messages and how they are typed, a brush stroke is created. In regards to tree visualization, Etemad and Carpendale's ShamsehTree [EC09] is a visualization for large trees, that uses a nested layout, where trees are mapped to a pattern that mimics Shamseh, a pattern often used in decorative Persian ornaments. Etemad et al.'s PaisleyTree [EBB\*14] introduced a hybrid visualization of trees combining node-link, adjacency and nested layouts and mapping parts of the trees to Paisley floral patterns. While our goal is similar to these, graphs have more complex structures than trees. The interconnections between nodes, particularly in dense graphs, make the mapping between graph and floral pattern much harder.

### 3. Daisy Layout Mapping and Encoding

In this section, we introduce Daisy layout for the visualization of directed graphs which is inspired by ornamental patterns of daisy flowers.

#### 3.1. Daisy Layout

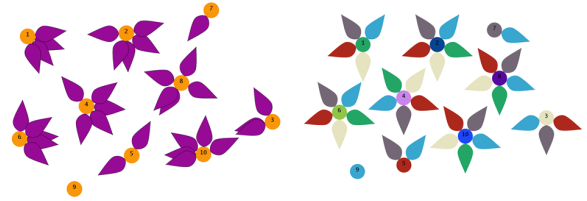
In Daisy layout, nodes are represented by circles (the center of the daisy) and edges by linear elements attached to source nodes (petals). Figure 5 shows the transition from traditional node-link to daisy representation. The second row of Figure 5 shows that edges can be replaced by partial edges. These partial edges can be replaced by petals, starting from the source. The direction of each petal points to the destination node (direction constraints). Thus, edges are represented by linear elements attached to the nodes (i.e. adjacency layout). For visualizing directed graphs, Daisy layout can be modified as shown in Figure 5-right, only outgoing edges are mapped to petals. Directed graphs result in less clutter.



**Figure 5:** Mapping edges to daisy petals. Left: undirected edges Right: directed edges. Top: nodes are connected with traditional edge. Mid: edges are shortened. Bottom: short edges are replaced by petals.

We first colored all daisy centers with one color and all edges (daisy petals) with another color. However, as seen in Figure 6-left

the overall representation is different from daisy ornamental patterns. **Also as it is evidenced in the figure, petals are overlapping, and in some cases it might be confusing to see the connections.** Traditionally, the arrangement of petals around the center is usually symmetric. The symmetry could be satisfied if all edges (petals) are distributed symmetrically around a node. However, edges in our first design point to the destination node. In addition to the possibility of unbalanced distribution of petals, in large and crowded graphs, this direction may be blocked with other nodes, which could make reading the destination hard and ambiguous.



**Figure 6:** Directed graph with 10 nodes 35 edges. Left: non-symmetric arrangement, petals are oriented toward their destination nodes (directional constraint). Right: symmetric arrangement, petals are uniformly distributed around the node's center. The color of each edge represents its destination node (color constraint).

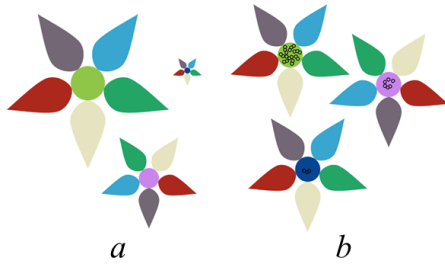
In order to have a symmetric arrangement of petals around a daisy center, we assigned different colors to each node. Since daisy petals are positioned on the perimeter of their source node, we choose the destination node's color for coloring the petal as is shown in Figure 6-right. The direction and color constraints of petals together help readability of daisy graphs. However, those constraints can be loosened for different scenarios. For example, if the similarity with the floral patterns is more important than the ease of reading edge connectivity, we can remove the directional constraints to distribute petals symmetrically around the node. In this symmetric layout, the color of petals implies the destination node. In summary, the choice between symmetric and non-symmetric arrangement (directional constraint) may depend on the application.

#### 3.2. Node and Edge Weight

In ecological networks, weights can be assigned to both edges and nodes of graphs. In our Daisy Visualization, we have considered several methods for depicting weights. Figure 7 shows two methods of mapping the weight for three nodes. In the first method, the weight of the nodes is mapped proportionally to the size of the node's circle (see Figure 7-a). In the second method, the weight is mapped to the number of small flower seeds inside of the flower's node (Figure 7-b).

Slight variation in the size of the daisy cores exists in nature and artworks but extreme variation in size is unusual. Therefore, the mapping of the weight to the size might only be appropriate when the range of node weights does not cause extreme variation in the size of the flowers. While use of logarithmic functions might help to reduce the size variation, the non-linear mapping might cause confusion.

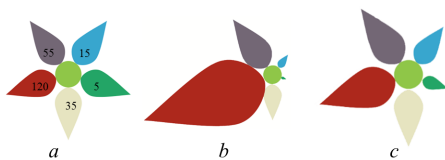




**Figure 7:** Weight of the node can be mapped proportionally to the size of the flower core (b) or to the number of flower seeds inside the circle (a). Node weights are: 3, 6, and 20.

Flower seeds are also visible features in nature and many artworks. These seeds can be depicted by smaller circles inside the node's flower center. The weight of the node can be proportionally mapped to the number of seeds drawn in the nodes. Again an aspect to consider is creating a suitable size range for the number of seeds. Importantly, the size of the seeds should be determined such that the space used by all the seeds never exceeds the size of the node's circle. Any arrangement (e.g. uniform, spiral, phyllotactic [Kuh07]) can be used for distributing seeds in the node's space [EC09].

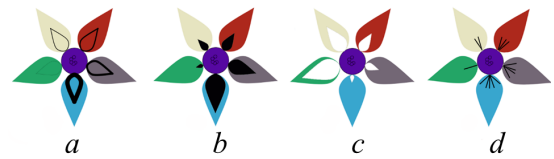
For assigning weight to the edges, we have also explored several methods. One possible method is to map the weight of the edge to the size of the petal. The variability of the petals' size in a single flower is very low (less than the node variation) in nature and artworks. Therefore, it is better if the mapped range of petal weights do not radically change the size of the petals (see Figure 8-b). This makes the weights less visible for edges (see Figure 8-c) so we have examined other methods too.



**Figure 8:** Edge weights can be mapped to the size of daisy petals by direct mapping (b) or logarithmic mapping (c).

An alternative would be to keep the size of daisy petal constant but map the weights into a feature inside petals. The space inside of each petal provides a good opportunity for placing various visual clues for the weight. An easy answer is to put a label showing the weight (see Figure 8 (a)). However, to make the visualization closer to floral patterns, we have explored four different designs for this objective. In these designs, we have tried to map the weight into *venation features* [PHN08], an abstraction of venation patterns in the petal is shown in Figure 9. The venation feature in these four methods is represented by:

1. a stroke whose thickness is proportional to the weight,
2. a filled (black) droplet (sub petal) whose size is proportional to the weight,
3. a filled (white) droplet whose size is inversely proportional to the weight (i.e. the remaining space of the petal depicts the weight),
4. a set of lines or curves passing through a single point (e.g. the base of the petal) where the number of lines is proportional to the weight.



**Figure 9:** Edge weight can be mapped to venation features inside petals.

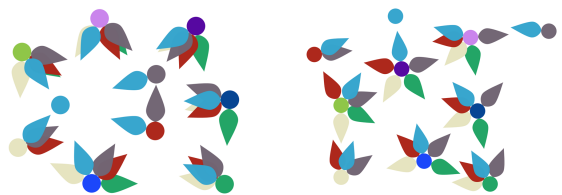
All these variations can be found in floral artworks (for example, see Figure 10).



**Figure 10:** Various venation patterns in artworks [Gra].

### 3.3. Node Arrangement

Since edges are only partially presented in Daisy layout, we have the freedom of relocation nodes without any constraints commonly imposed by edge crossing and edge length factors. Consequently, different arrangements can be used to position the nodes (e.g. Phyllotactic patterns [NCA06], Voronoi [ES86], symmetric [EC09]). In the case of the arrangement with directional constraint, moving nodes can change the petals' orientations. In extreme cases, petals of one flower may intersect other petals (see Figure 11, left) while there is still enough space around the node. A simple interactive tool can help to modify the arrangement to mitigate this issue (see Figure 11, right).



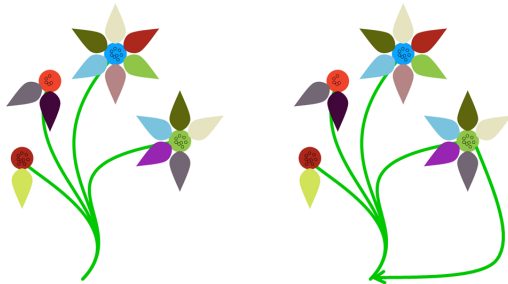
**Figure 11:** Left: With directional constraints on edge petals, sometimes they may overlap. Right: Nodes can interactively be moved to be arranged with less overlaps.

Alternatively, symmetric layout (no directional constraint) can be used as discussed in Section 3.1. To prevent overlapping between petals of different nodes, a larger circle containing the entire flower (core and all the petals) of daisy can be used as the nodes' bounding area (bounding circle).

#### 4. Daisy Visualization for Ecological Network

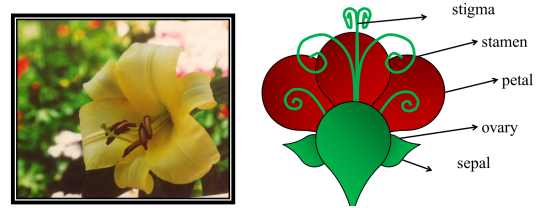
We explore Daisy Visualization’s potential for including more data features into the arrangements, to mimic floral patterns in the context of ecological network visualization. As demonstrated in Figure 2, there are four types of edges in ecological networks (input, output, exchange and respiration). Exchange edges represent the amount of energy/matter that transfers between species in the ecosystem. Inputs/Outputs are the amount of energy/matter that enters and leaves the ecosystem. In practical cases, it is possible to have multiple attribute outputs. In the example networks provided by our ecologist colleague, in addition to output energy, there exists respiration or breathing as the second type of output edges. The challenge is how to depict these multiple attributes with suitable visual features. In ornamental daisy patterns, there are many elements around the flowers that can be used as inspiration for representing attributes in ecological networks (or other multi-attributes networks).

Exchange edges can be treated as directional edges, thus nodes and exchange edges are mapped to the daisy centers and petals respectively. However, we need a new solution for other types of edges. Since input and output edges show transactions of nodes to the *outside* of the system, a simple solution could be to use a phantom node for representing the outside. This special node can be treated similar to other nodes or handled in a different way. In our visualization, rather than using another flower for the phantom node, we introduce an alternative solution. As seen in our previous examples (e.g. Figure 6), our patterns are missing any stem or branching structure, which are important elements that exist in both abstract and real floral patterns. To address this issue, we map the outside (phantom) node to the root of the flower. Therefore, input edges show the transaction from the root to each node. With this metaphor, we can map each input edge to a branch from the root to that node (see Figure 12).



**Figure 12:** Left: Daisy Visualization with input edges. Right: Same visualization with one output edge presented by stems, similar to the input edges. Using the same phantom node for inputs and outputs causes confusion.

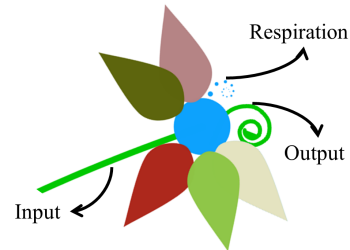
The same strategy can be used for output edges. However, using another branch for connecting the node back to the same root creates loops which is not usually acceptable for floral patterns (see Figure 12). Also, using a secondary phantom node may create flowers with two stems (one for the input and one for the output) which is also not common in floral patterns. Therefore, a different method is required for this type of edge. Interestingly, flowers have several



**Figure 13:** Flowers have several elements that can be used for mapping data attributes.

parts (e.g. pistil, filament and sepal) that can be used for representing other features (see Figure 13 for real flowers and Figure 10 for artwork exhibiting similar elements).

Inspired by these elements, in our visualization, output edges are represented by spiral leaflet shape attached to the node. The color used for these elements is the same as the branching structures (see Figure 14). With this consistency of color, we attempt to show that the input and output edges are connected to a unique outside node (phantom). For respiration we attached a small stamen to its node



**Figure 14:** External edges (e.g. input, output and respiration) can be mapped to other flower elements.

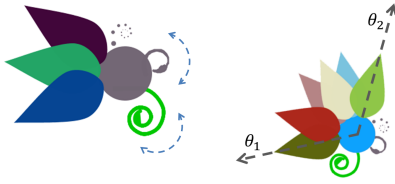
and color it the same as its node. Rendering them with a dashed or dotted lines can hint at respiration with the air (see Figure 14).

One of the uncommon attributes of ecological networks is the possibility of having loops for some of the nodes. For example, as shown in Figure 3, there is a loop exchange edge for the node “blue crab” in network. Our solution for this type of edges is to use another floral feature. We have sketched numerous shapes and features, and chose to use a circular type of leaflet attached to the node (see Figure 15-Left).

With these mappings we can represent entire ecological networks, with their complex structures, as variations of floral patterns. Although, our current representation is based on several iterations of designing floral elements and their mappings, it is only one feasible solution from many possibilities. The richness of floral patterns and their assorted elements enables us to map multiple attributes of nodes of the graph.

#### 4.1. Features Specific to Ecological Networks

Our implementation of Daisy Visualization supports some basic interaction techniques including: changing the positions of nodes;



**Figure 15:** Left: Interactive change of the position of cycle and output links. Right: Automatically finding the angular range of the neighbors of the current node.

changing the orientation of petals (see Figure 11-Left and Right); highlighting the traditional node-link relationships between a selected node and its adjacent nodes; toggling between symmetric and directional constraints; and displaying exact weights of nodes and edges. In addition to these interactions, we have implemented other interactions to support visualization tasks related to ecological networks.

The initial node arrangements in our Daisy Visualization can be modified by simple mouse/touch interactions. The petal's orientation is determined by chosen constraints. The arrangement of other floral elements (i.e. output and respiration) can be independent from the petal arrangements. For example, all of respirations can be oriented in one specific direction (e.g. the up vector, to convey the concept of the air). The same approach can be used for outputs by aligning all of their floral elements toward another point (e.g. east). In general, depending on the applications and the type of feature, the alignment of these directions can be determined. However, enforcing these constraints in addition to directional and color constraints may create unbalanced floral patterns.

Figure 15-Left, shows that a mouse/touch interaction for rotating the floral elements of respirations and outputs can help to improve the balance of the floral pattern in an interactive manner. Also, algorithmic methods can be used to create more balanced arrangements for extra floral elements. For example, one approach is to use the angular range  $[\theta_1, \theta_2]$  of the neighbors of the current vertex  $v$  (see Figure 15-Right). The complementary angle  $[\theta_2, \theta_1]$  shows the remaining space around the node  $v$  not used by the petals. So, if the complementary angle is large enough, it can be used to accommodate the respiration and output elements (see Figure 15-Right).

We have access to forty eight ecosystem data files provided by Professor Ulanowicz, Chesapeake Biological Laboratory, from the University of Maryland. The number of nodes in these real datasets ranges from five to one hundred twenty five. Thirty four data files contain less than thirty six nodes. While these graphs are not large they are complex. Figure 16, shows a screen shot of Node-link and Daisy Visualizations, created from one of these networks *Chesapeake Mesohaline ecosystem* with 15 nodes and 71 edges. The attributes such as node labels and biomass can be shown for the entire network or for a set of nodes highlighted interactively (see Figure 16). At the beginning of the paper, Figure 1, shows a screen shot of Node-link and Daisy Visualization, created for *Crystal River Creek* ecosystem which has 21 species and 82 exchange edges and 129 edges in total.

**Implementation.** Daisy Visualization was developed with Processing 2.12. Most floral elements (e.g. petals) were directly coded

in this environment. For complex floral patterns (e.g. leaflets and loops), an interactive B-spline curve editor was used and the resulting curves were exported to the prototype.

## 5. Studying Daisy Visualization

We conducted a qualitative study to explore questions about how understandable Daisy layout is and to obtain input for our design decisions for its layout (e.g. symmetric versus directional arrangements) and obtain general impressions about the overall design.

**Participants.** We interviewed 19 participants (18 to 45 years: 13 female). Two participants had approximately two years of experience with Ecological Networks and the rest had more general backgrounds such as professional designers, professional computer scientists and university students.

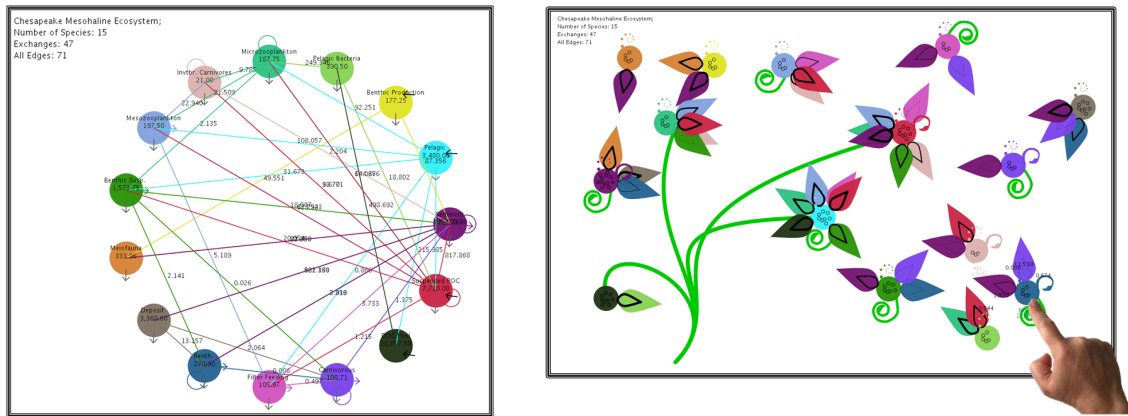
**Setup.** Participants used a Microsoft Surface Pro with windows 8 OS using touch/stylus-pen interactions.

**Procedure.** We started with a brief tutorial and gave participants the opportunity to play with both arrangements (symmetric and directional) (See Figure 17). Next, we asked participants to select an arrangement and then, on this arrangement, perform a short list of graph structure tasks related to the connectivity of the graph and the visual encoding of weights [ELCF15]: **Task 1: Which node is the heaviest node in the graph? Task 2: What is the weight of the selected node? Task 3: Which outgoing link from the selected node is the heaviest? Task 4: Which nodes are connected to the selected node? Task 5: Compare two specific nodes, which one is heavier?** After finishing the tasks, participants gave their opinions about the design decisions for Daisy Visualization using a five place Likert scale. The questionnaire was visual with both the needed images and the questions below:

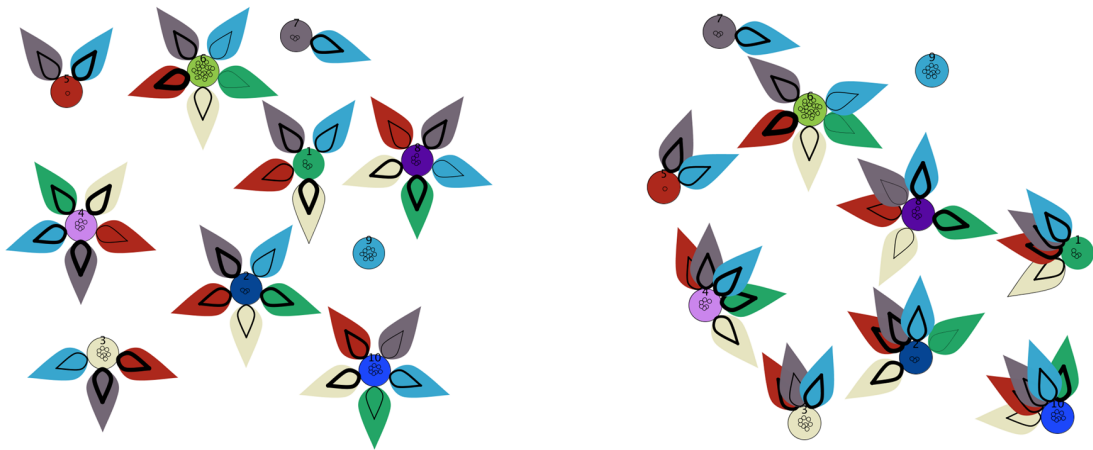
1. Mapping nodes and edges to daisy flowers.
2. Assigning colors to nodes and using directional constraint(see Figure 11-right).
3. Arranging daisy petals symmetrically (see Figure 11-left).
4. Using the size of the flower center for mapping node's weight.
5. Using flower seeds for mapping node's weight.
6. Mapping edge weight to the petal's size (See Figure 8).
7. Mapping edge's weight to the thickness of the petal's venation (See Figure 9-a).
8. Mapping edge's weight to droplet size (See Figure 9-b).
9. Mapping edge's weight to a droplet whose size is inversely proportional to the weight (see Figure 9-c).
10. Mapping edge's weight to the petal's venation lines (see Figure 9-d).

In order to receive qualitative feedback about the overall design, we asked the following open ended question: "Please describe what you learned or found interesting about Daisy Visualization for weighted directed graphs during this session. There is no wrong answer". Finally, during a short exit interview, we asked the same question orally and gave a chance to the participants to express their feedback freely.

**Results.** We have collected the results of participants' response to the visual questions and assembled them into the chart shown in



**Figure 16:** “Chesapeake Mesohaline ecosystem”. Left: traditional node-link, Right: Daisy Visualization, where details of the ecological network (e.g. input, output, respiration) are mapped to floral elements.



**Figure 17:** These two arrangements were presented to participants (left: symmetric, right: directional) and they are asked to perform tasks on them.

Table 1. Participants also selected their favorite from our five different designs for representing edge’s weight (see Figure 8 and 9). **The result shows that 6 people chose the design (b), 5 the design (d), 4 the design (a), 3 the design (c) and 1 person selected the design in Figure 8.** The accuracy of the graph structure task did not depend on the arrangement selected and was reasonable. For tasks 1 to 5 the result are respectively: 98%, 100%, 68%, 74%, 95%.

## 6. Discussion

Our primary goal was to gain a deeper understanding about whether daisy layout is understandable and to get some feedback about the design decisions. We asked participants to do the graph structure tasks to know that each participant had thought about these aspects of the graph, essentially to make them ready to fill the questionnaire. Since 10 participants chose directional layout and 9 chose symmetric layout performance can be used as a rough indicator to see if they understand the layout. For initial task, 10 participants

preferred the directionally constrained layout because the orientation of petal helped them to see the destination node. Also, they liked the effect that moving a node caused its petals, and petals of its adjacent flowers, rotate to maintain the directional constraint. On the other hand, 9 participants liked the symmetrical layout. They found the petal/node color coding sufficient to find the destination nodes and preferred to have a more symmetric design. Also, they preferred the symmetric arrangement because petals overlapped less and because the overall presentation is closer to daisy floral patterns.

Written comments were, in general very positive, with our participants using words like appealing, pleasing, interesting, colorful and eye-popping, and declaring which has smart design choices for simplifying the graph visualization. Some quotes include: “I like the use of stem even for the selected node”; “it is clear with no edge crossing”; “easy to identify heavier nodes and edges”; “the elimination of overlapping is interesting”; and “easy to see incoming edges and find the heaviest edge”. Participants appreciated having



## PARTICIPANTS FEEDBACK ON DAISY VISUALIZATION

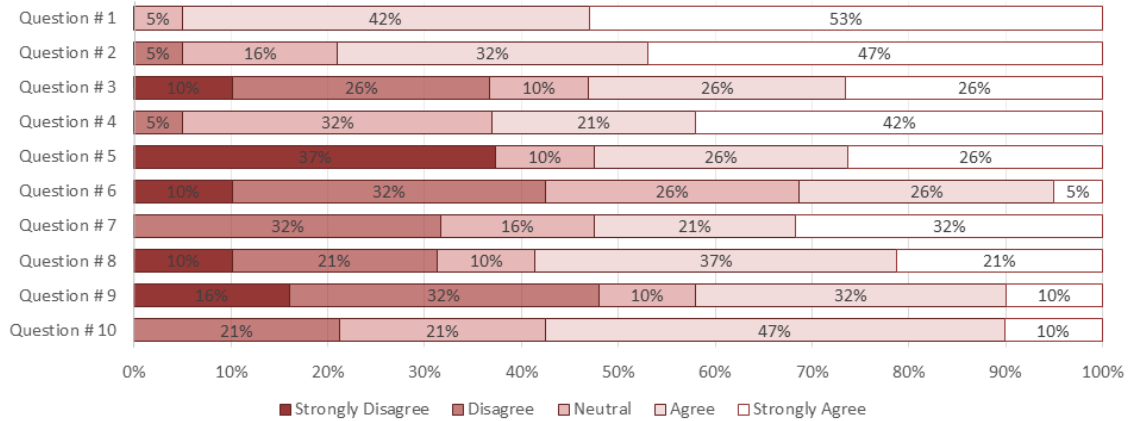


Table 1: Participants' feedback about Daisy Visualization.

less edge cluttering through use of petals, use of the stem for the source of energy in ecosystems, and the color encoding.

Some of our participants raised concerns about not seeing weights clearly. However, this is a problem shared with other uses of size and thickness to visual encoding of the weights. These visual encodings show relative ordering rather than specific weights. In essence, it is hard to recognize the exact numeric values from these visual encoding. That these encodings only give a visual cue about the relative differences was understood by some of our participants. Interactions such as tool tips can reveal the exact numeric attributes.

The results of this study can be used to narrow down some of the possible design choices for encoding weights and attributes. For encoding edge weight, it seems that the resizing petals (see Figure 8) is not an effective choice in comparison with the other possibilities (see Figure 9). Also, for encoding node weight, there was a strong preference to use flower seeds. However, the preferences between directional and symmetrical edge petal layout seems to be quite balanced.

## 7. Conclusion

In this paper, we have presented Daisy Visualization, a novel graph layout inspired by ornamental daisy patterns. In this visualization, nodes, edges and other features of data are mapped to floral elements. More specifically, nodes are replaced by a colored circle as the flower's center and edges are encoded as petals of that flower. **The goal is to present weighted directed graphs in a more creative and novel visualization. However, since Daisy visualization relies on distinguishable colors, it might limit the range of applications for this visualization. One solution will be to use a combination of patterns and textures along with various hues, tints, shades, and tones, to represent different nodes in larger graphs.**

We illustrated the development of Daisy Visualization through a use case of ecological networks of real ecosystem data-sets. We

extended the initial visual encoding of this visualization to support specific attributes of ecological networks (e.g. input/output edges, respiration). In presenting Daisy Visualization we have described the process of leveraging ornamental daisy patterns to arrive at many possibilities of new ways to encode ecosystem data-sets data.

To develop a better understanding of Daisy Visualization, we conducted a qualitative study. The main goal of this study was to shed light on overall designs of our layouts and the design decisions for Daisy Visualization. In general, the participants liked the idea of representing graph with decorative patterns. They mentioned it is more interesting and made comments about it being easier to understand. Some of our design decisions received especially positive feedback, such as mapping edge weights to features inside daisy petals.

## References

- [ABHR\*13] ALPER B., BACH B., HENRY RICHE N., ISENBERG T., FEKETE J.-D.: Weighted graph comparison techniques for brain connectivity analysis. In *Proceedings of the SIGCHI Conference on Human Factors in Computing Systems* (2013), ACM, pp. 483–492. 3
- [BF14] BATTISTA G. D., FRATI F.: A survey on small-area planar graph drawing. *CoRR abs/1410.1006* (2014). 2
- [BM76] BONDY J. A., MURTY U. S. R.: *Graph theory with applications*, vol. 290. Macmillan London, 1976. 3
- [BSPW14] BURCH M., SCHMAUDER H., PANAGIOTIDIS A., WEISKOPF D.: Partial link drawings for nodes, links, and regions of interest. In *Information Visualisation (IV), 2014 18th International Conference on* (2014), IEEE, pp. 53–58. 3
- [BU89] BAIRD D., ULANOWICZ R. E.: The seasonal dynamics of the chesapeake bay ecosystem. *Ecological Monographs* 59, 4 (1989), 329–364. 3
- [BVKW11] BURCH M., VEHLow C., KONEVTSOVA N., WEISKOPF D.: Evaluating partially drawn links for directed graph edges. In *Graph Drawing* (2011), Springer, pp. 226–237. 3
- [CKN\*03] COLLBERG C., KOBouROV S., NAGRA J., PITTS J., WAMPLER K.: A system for graph-based visualization of the evolution of software. In *Proceedings of the 2003 ACM symposium on Software visualization* (2003), ACM, pp. 77–212. 3

- [CM07] CAWTHON N., MOERE A. V.: The effect of aesthetic on the usability of data visualization. In *Information Visualization, 2007. IV'07. 11th International Conference* (2007), IEEE, pp. 637–648. 2
- [DBETT94] DI BATTISTA G., EADES P., TAMASSIA R., TOLLIS I. G.: Algorithms for drawing graphs: an annotated bibliography. *Computational Geometry* 4, 5 (1994), 235–282. 2
- [EBB\*14] ETEMAD K., BAUR D., BROSZ J., CARPENDALE S., SAMAVATI F. F.: Paisleytrees: A size-invariant tree visualization. *EAI Endorsed Transactions on Creative Technologies* 14, 1 (10 2014). 4
- [EC09] ETEMAD K., CARPENDALE S.: Shamshtrees: Providing hierarchical context for nodes of interest. In *Proceedings of Bridges 2009: Mathematics, Music, Art, Architecture, and Culture* (2009), Kaplan C. S., Sarhangi R., (Eds.), Tarquin Books, pp. 293–300. 4, 5
- [ECS] ETEMAD K., CARPENDALE S., SAMAVATI F.: Node-ring graph visualization clears edge congestion. *Proceedings of the IEEE VIS Arts Program (VISAP)*, 67–74. 3
- [ECS14] ETEMAD K., CARPENDALE S., SAMAVATI F.: Spirograph inspired visualization of ecological networks. In *Proceedings of the Workshop on Computational Aesthetics* (2014), ACM, pp. 81–91. 3
- [ECW\*12] EPSKAMP S., CRAMER A. O., WALDORP L. J., SCHMITTMANN V. D., BORSBOOM D.: qgraph: Network visualizations of relationships in psychometric data. *Journal of Statistical Software* 48, 4 (5 2012), 1–18. 3
- [EL00] EADES P., LIN X.: Spring algorithms and symmetry. *Theoretical Computer Science* 240, 2 (2000), 379–405. 2
- [ELCF15] ETEMADPOUR R., LINSEN L., CRICK C., FORBES A.: A user-centric taxonomy for multidimensional data projection tasks. In *Proceedings of the international conference on information visualization theory and applications (IVAPP), Berlin* (2015), pp. 11–14. 7
- [ES86] EDELSBRUNNER H., SEIDEL R.: Voronoi diagrams and arrangements. *Discrete and Computational Geometry* 1, 1 (1986), 25–44. 5
- [ESK05] EIGLSPERGER M., SIEBENHALLER M., KAUFMANN M.: An efficient implementation of sugiyama's algorithm for layered graph drawing. In *Graph Drawing* (2005), Springer, pp. 155–166. 3
- [ESP08] ETEMAD K., SAMAVATI F. F., PRUSINKIEWICZ P.: Animating persian floral patterns. In *Proceedings of the Fourth Eurographics conference on Computational Aesthetics in Graphics, Visualization and Imaging* (2008), Eurographics Association, pp. 25–32. 3, 4
- [Gra] GRAPHICSKEEPER: Colorful floral pattern. <http://graphicskeeper.com/vector/colorful-floral-pattern/respond>. Accessed: 2015-03-08. 5
- [HMM00] HERMAN I., MELANÇON G., MARSHALL M. S.: Graph visualization and navigation in information visualization: A survey. *IEEE Transactions on Visualization and Computer Graphics* 6, 1 (Jan. 2000), 24–43. 3
- [HS12] HAMEKASI N., SAMAVATI F.: Designing persian floral patterns using circle packing. In *GRAPP/IVAPP* (2012), Citeseer, pp. 135–142. 4
- [HvW09] HOLTEN D., VAN WIJK J. J.: A user study on visualizing directed edges in graphs. In *Proceedings of the SIGCHI Conference on Human Factors in Computing Systems* (2009), ACM, pp. 2299–2308. 3
- [KDMW16] KIEFFER S., DWYER T., MARRIOTT K., WYBROW M.: Hola: Human-like orthogonal network layout. *Visualization and Computer Graphics, IEEE Transactions on* 22, 1 (2016), 349–358. 2
- [Kuh07] KUHLEMEIER C.: Phyllotaxis. *Trends in plant science* 12, 4 (2007), 143–150. 5
- [KvDWVW01] KLEIBERG E., VAN DE WETERING H., VAN WIJK J. J.: Botanical visualization of huge hierarchies. In *infovis* (2001), IEEE, p. 87. 3
- [KW03] KAUFMANN M., WAGNER D.: *Drawing graphs: methods and models*, vol. 2025. Springer, 2003. 2
- [Mun14] MUNZNER T.: *Visualization Analysis and Design*. CRC Press, 2014. 2
- [NCA06] NEUMANN P., CARPENDALE M. S. T., AGARAWALA A.: Phyllotrees: Phyllotactic patterns for tree layout. In *EuroVis* (2006), vol. 6, Citeseer, pp. 59–66. 3, 5
- [NTZC07] NEUMANN P., TAT A., ZUK T., CARPENDALE M. S. T.: Keystrokes: Personalizing typed text with visualization. In *EuroVis* (2007), vol. 43, p. 2007. 4
- [Pal65] PALLADIO A.: *The four books of architecture*, vol. 1. Courier Corporation, 1965. 3
- [PHN08] PARK J., HWANG E., NAM Y.: Utilizing venation features for efficient leaf image retrieval. *Journal of Systems and Software* 81, 1 (2008), 71–82. 5
- [PL96] PRUSINKIEWICZ P., LINDENMAYER A.: *The algorithmic beauty of plants*. Springer-Verlag New York, Inc., New York, NY, USA, 1996. 3
- [PSM07] POUSMAN Z., STASKO J., MATEAS M.: Casual information visualization: Depictions of data in everyday life. *Visualization and Computer Graphics, IEEE Transactions on* 13, 6 (Nov 2007), 1145–1152. 2
- [Pur97] PURCHASE H.: Which aesthetic has the greatest effect on human understanding? In *Graph Drawing* (1997), Springer, pp. 248–261. 2
- [SLH03] SKOG T., LJUNGBLAD S., HOLMQUIST L.: Between aesthetics and utility: designing ambient information visualizations. In *Information Visualization, 2003. INFOVIS 2003. IEEE Symposium on* (Oct 2003), pp. 233–240. 2
- [Smi84] SMITH D. R.: The synthesis of lisp programs from examples: A survey. *Automatic program construction techniques* (1984), 307–324. 3
- [Ula] ULANOWICZ R. E.: *Circumscribed Complexity in Ecological Networks*. Wiley VCH Verlag GmbH and Co. KGaA. 2, 3
- [Ula04] ULANOWICZ R. E.: Quantitative methods for ecological network analysis. *Computational Biology and Chemistry* 28, 5 (2004), 321–339. 3
- [vHSD09] VAN HAM F., SCHULZ H.-J., DIMICCO J. M.: Honeycomb: Visual analysis of large scale social networks. In *Human-Computer Interaction-INTERACT 2009*. Springer, 2009, pp. 429–442. 3
- [vLKS\*] VON LANDESBERGER T., KUIJPER A., SCHRECK T., KOHLHAMMER J., VAN WIJK J., FEKETE J.-D., FELLNER D.: Visual analysis of large graphs: State-of-the-art and future research challenges. *Computer Graphics Forum* 30, 6. 3
- [WZS98] WONG M. T., ZONGKER D. E., SALESIN D. H.: Computer-generated floral ornament. In *Proceedings of the 25th annual conference on Computer graphics and interactive techniques* (1998), ACM, pp. 423–434. 3
- [Zha07] ZHANG K.: From abstract painting to information visualization. *Computer Graphics and Applications, IEEE* 27, 3 (2007), 12–16. 2